

# SHARPSINKS

A DIVISION OF ESI

*Serenity*  
**CERAMIC  
COLLECTION**

STATE-OF-THE-ART MANUFACTURING PROCESSES  
SPECIALIZED FORMING, GLAZING, AND FIRING TECHNIQUES  
HIGHEST QUALITY CLAYS & ACID-RESISTANT GLAZES  
ASME A112.19.2 COMPLIANT

## VC10

Undermount Oval  
Porcelain Ceramic Sink  
Integral Overflow  
ASME A112.19.2 Compliant  
DXF CAD Files Available

### COLORS



WHITE



BISQUE

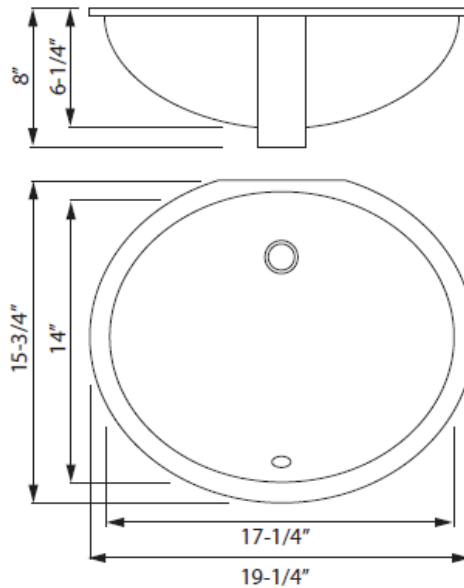

a J.R. Sharp Company

## SHARPSINKS

A DIVISION OF ESI

800-470-5831

[www.esi4service.com](http://www.esi4service.com)

DALLAS, TX  
DENVER, CO  
LOS ANGELES, CA  
PHOENIX, AZ

SALT LAKE CITY, UT  
SAN FRANCISCO, CA  
SEATTLE, WA  
ST. LOUIS, MO