

# SHARPSINKS

A DIVISION OF ESI

## CULINARY TRADITIONS

18 GAUGE SINK CONSTRUCTION  
304 STAINLESS STEEL  
10" DEPTH  
COMMERCIAL GRADE UNDERCOATING  
ZERO RADIUS CORNERS  
HEAVY DUTY SOUND DAMPENING PADS

## CT100-18

18 Gauge Construction  
Handmade  
304 Series Stainless Steel  
18/8 Chrome-Nickel Content  
Fully Insulated Spray Coating  
Sound Dampening Pads  
Satin Finish  
ASME 112.19.3-00  
IAPMO/UPC Compliant

Includes  
Mounting Clips  
Paper Template  
DXF CAD Files Available

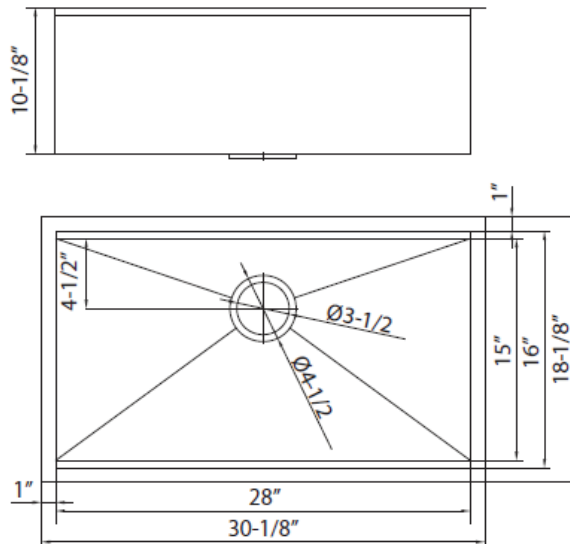

a J.R. Sharp Company

## SHARPSINKS

A DIVISION OF ESI

800-470-5831

[www.esi4service.com](http://www.esi4service.com)

DALLAS, TX  
DENVER, CO  
LOS ANGELES, CA  
PHOENIX, AZ

SALT LAKE CITY, UT  
SAN FRANCISCO, CA  
SEATTLE, WA  
ST. LOUIS, MO